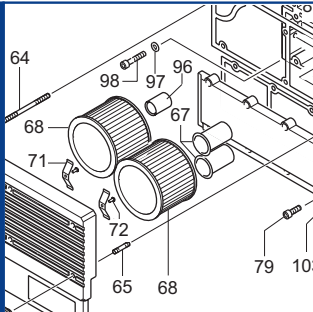

DVT 3.140

SERVICE

BECKER
Qingou - PR CHINA
www.becker-international.com

No. **W** year XXXX Index Variante

type **DVT 3.140-XX**

frequency XXXX Hz

speed XXXX min⁻¹

power required XXXX kW

inlet capacity XXXX m³/h

pressure + XXXX mbar

vacuum - XXXX mbar

Made in China

WU 87-1-02

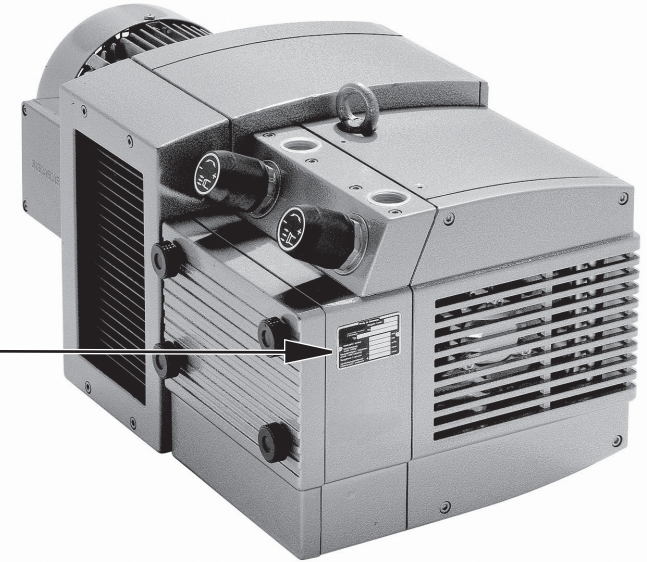

Ersatzteilliste
Spare parts list
Liste de pièces de rechange
Listino pezzi di ricambio
Lista de piezas de recambio
Lista de peças sobresselentes
Reserveonderdelenlijst
Atsarginių dalių sąrašas
Varuosad nimekirja
Rezerves daļu saraksts

Reservdeliste
Reservdelista
Varaosuettelo
Reservdeliste
Wykaz części zamiennych
Tartalékalkatrész lista
Seznam náhradních dílů
Seznam nadomestnih delov
Zoznam náhradných dielov
Rezervni dijelovi popis

Lista pieselor de schimb
Páirteanna spártha liosta
Κατάλογος ανταλλακτικών
Yedek parça listesi
Списък на резервните части
Перечень запасных частей
スเปアパーツリスト
예비 부품 목록
备用零件目录

SERVICE

www.becker-international.com

Sales and service network

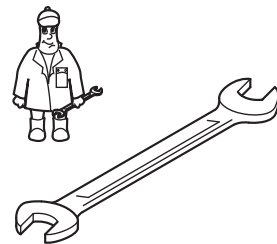

Wartung
Maintenance
Entretien
Manutenzione
Mantenimiento



Pos.	Menge ²⁾ Quantity Quantité Quantità Cantidad	Bestell-Nr. Ident No. No. Identification No. Identificazione No. de pedido	Bezeichnung Description Designation Designazione Descripción
□	1	549000 21300	Dichtungssatz, Complete set of seals, Jeu de joints, Kit di guarnizioni, Junta Completa
11	SATZ/KIT	901334 00007	Schieber, Rotor Vane, Palette, Empujador
68	2	909507 00000	Filterpatrone, Filter cartridge, Cartouche Filtrante, Cartuccia filtro, Cartucho de filtro
91	1	909514 00000	Filterpatrone, Filter cartridge, Cartouche Filtrante, Cartuccia filtro, Cartucho de filtro

²⁾ erforderliche Bestellmenge / necessary order quantity / quantité nécessaire / quantità di ordinazione necessari / cantidad necesario

DVT 3.140 Standard

Variante

DVT 3.140/XX

①

1.+2.Ansaugung
 1.+2.suction
 1.+2.aspiration
 1.+2.aspirazione
 1.+2.aspiración

②

US-Motoranschluß
 US motor
 US moteur
 US motore
 US motor

③

/0-56
 - erhöhter Volumenstrom
 - increased volume flow
 - d'augmentation de débit
 - aumento del volume di flusso
 - aumento del volumen de flujo

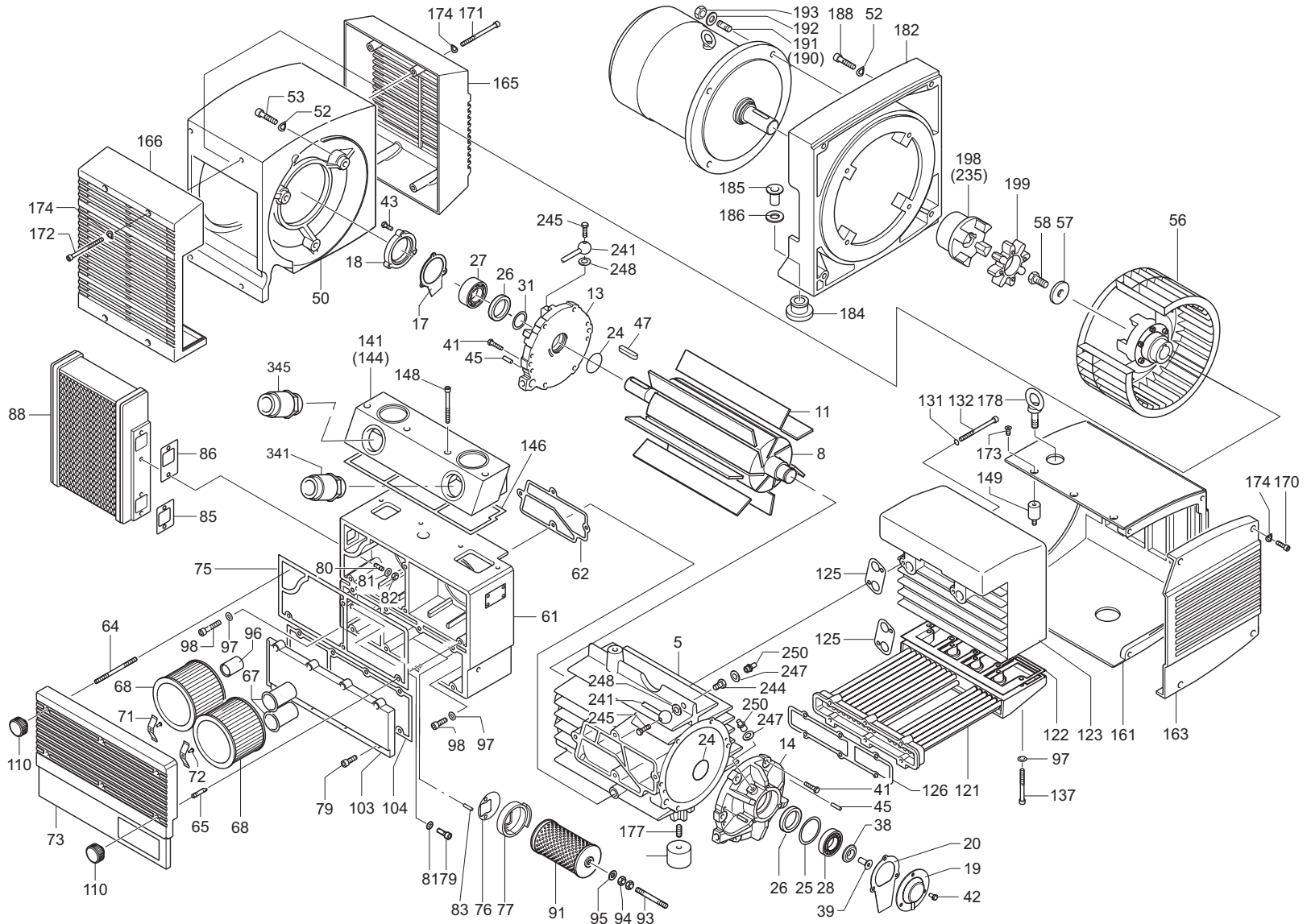
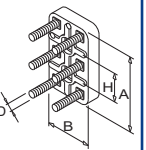
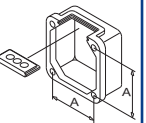
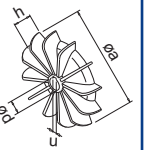
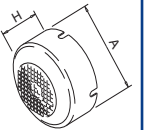
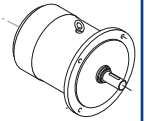

SERVICE

W INDEX	Pos.	Bestell Nr.	Beschreibung	DE	
DVT 3.140	■	549000 21300	DICHTUNGSSATZ ¹⁾		
	5	000100 21300	GEHÄUSE		
	8	020002 21300	KOLBEN		
	11	901334 00007	SCHIEBER (SATZ)		
	13	000800 21300	SEITENDECKEL, LINKS		
	14	000700 21300	SEITENDECKEL, RECHTS		
	17	025512 21300	DICHTUNG		
	18	001101 21300	LAGERDECKEL		
	19	001006 21300	LAGERDECKEL		
	20	025513 21300	DICHTUNG		
	24	911305 00000	DICHTUNGSSCHLAUCH		
	25	917159 00000	AUSGLEICHSCHEIBE		
	26	906544 00000	WELLENDICHRING		
	27	906621 00000	WÄLZLAGER		
	28	906664 00000	WÄLZLAGER		
	31	511400 10400	SATZ DISTANZSCHEIBEN		
	38	016801 21300	SPANNSCHEIBE		
	39	949807 00000	SENKSCBRAUBE		
	41	945224 00000	SECHSKANTSCHRAUBE		
	42	945218 00000	SECHSKANTSCHRAUBE		
	43	901804 00000	SECHSKANTSCHRAUBE		
	45	948742 00000	PASSKERBSTIFT		
	47	947736 00000	PASSFEDER		
	50	053201 21300	LATERNE		
	52	950308 00000	UNTERLEGSCHEIBE		
	53	945331 00000	INNENSECHSKANTSCHRAUBE		
	56	544500 21300	KUPPLUNGSHÄLFTE MIT VENTILATOR		
	57	949409 00000	UNTERLEGSCHEIBE		
	58	945270 00000	WELLENENDSCHRAUBE		
	61	040102 21300	FILTERGEHÄUSE		
	62	025501 21300	DICHTUNG		
	64	951009 00000	STIFTSCHRAUBE		
	65	951003 00000	STIFTSCHRAUBE		
	67	964407 00000	SCHALLDÄMPFERROHR		
	68	909507 00000	FILTERPATRONE (2x) ²⁾		
	71	009000 27000	ANPRESSFEDER		
	72	948750 00000	BLINDNIET		
	73	040204 21300	FILTERDECKEL		
	75	025518 21300	DICHTUNG		
	76	025516 21100	DICHTUNG		
	77	022802 21100	FILTERTRÄGER		
	79	945321 00000	INNENSECHSKANTSCHRAUBE		
	80	946971 00000	STIFTSCHRAUBE		
	81	947504 00000	UNTERLEGSCHEIBE		
	82	947104 00000	SECHSKANTMUTTER		
	83	952019 00000	SPANNHÜLSE		
	85	025514 21100	DICHTUNG		
	86	025515 21100	DICHTUNG		
	88	560203 21300	KUEHLER		
	91	909514 00000	FILTERPATRONE (1x) ²⁾		
	93	903800 70000	STIFTSCHRAUBE		
	94	947105 00000	SECHSKANTMUTTER		
	95	949450 00000	U-SCHEIBE		
	96	964446 00000	SCHALLDÄMPFERROHR		
	97	950304 00000	U-SCHEIBE		
	98	945321 00000	INNENSECHSKANTSCHRAUBE		
	103	068801 21300	STAUBABSCHIEDERDECKEL		
	104	025515 21300	DICHTUNG		
	110	921500 50000	HANDGRIFF		
	121	560204 21300	KÜHLER		

W INDEX	Pos.	Bestell Nr.	Beschreibung	DE	
	122	025506 21300	DICHTUNG		
	123	066802 21300	DRUCKANSCHLUSSKASTEN		
	125	025504 21300	DICHTUNG		
	126	025514 21300	DICHTUNG		
	131	948021 00000	DICHRING		
	132	945374 00020	INNENSECHSKANTSCHRAUBE		
	137	945322 00000	INNENSECHSKANTSCHRAUBE		
	141	016604 21300	ANSCHLUSSLEISTE		
	146	025507 21300	DICHTUNG		
	148	945364 00000	INNENSECHSKANTSCHRAUBE		
	149	741310 30000	GUMMIPUFFER		
	161	918300 21300	ABDECKHAUBE		
	163	920800 21300	LUFTLEITRING		
	163	920801 21300	LUFTLEITRING (DVT3.140/0-68)		
	165	960700 21300	LÜFTERHAUBE		
	166	960701 21300	LÜFTERHAUBE		
	170	945321 00010	INNENSECHSKANTSCHRAUBE		
	171	945371 00010	INNENSECHSKANTSCHRAUBE		
	172	945372 00010	INNENSECHSKANTSCHRAUBE		
	173	949806 00000	SENKSCBRAUBE		
	174	951703 00000	FEDERSCHEIBE		
	176	741302 00000	GUMMIPUFFER		
	177	945634 00000	GEWINDESTIFT		
	178	948802 00000	RINGSCHRAUBE		
	182	014903 21300	ZWISCHENFLANSCH (B5-300)		
	184	951916 00000	KABELTÜLLE		
	185	948772 00000	ROHRNIETE		
	186	947508 00000	UNTERLEGSCHEIBE		
	188	945335 00000	INNENSECHSKANTSCHRAUBE		
	191	951022 00000	STIFTSCHRAUBE		
	192	947506 00000	UNTERLEGSCHEIBE		
	193	947106 00000	SECHSKANTMUTTER		
	198	902100 21900	KUPPLUNGSHÄLFTE (MOT)		
	199	902210 00000	KUPPLUNGSSCHEIBE		
	241	012200 21300	LEITUNG		
	244	912300 00000	ANSCHLUSSSCHRAUBE		
	245	009400 19000	KUGELSTÜCKSCHRAUBE		
	247	948074 00000	DICHRING		
	248	948021 00000	DICHRING		
	250	949002 00000	SCHMIERNIPPEL		
	341	736000 99624	VAKUUMREGULIERVENTIL (-0,6 BAR)		
	345	728000 99622	DRUCKREGULIERVENTIL (+0,6 BAR)		
		743303 00000	SPEZIALFETT (FETTPRESSE, 50g)		

¹⁾ Dichtungssatz - 54900021300 - Pos.: 17, 20, 24, 62, 75, 76, 85, 86, 104, 122, 125, 126, 146
²⁾ erforderliche Bestellmenge / Wartung

W INDEX	Pos.	Ident No.	Description	
DVT 3.140	■	549000 21300	GASKET SET ¹⁾	
	5	000100 21300	PUMP BODY	
	8	020002 21300	ROTOR	
	11	901334 00007	CARBON VANES (KIT)	
	13	000800 21300	LID, LEFT	
	14	000700 21300	LID, RIGHT	
	17	025512 21300	GASKET	
	18	001101 21300	BEARING COVER	
	19	001006 21300	BEARING COVER	
	20	025513 21300	GASKET	
	24	911305 00000	SEAL	
	25	917159 00000	COMPENSATING DISC	
	26	906544 00000	SHAFT-SEALING RING	
	27	906621 00000	BALL BEARING	
	28	906664 00000	BALL BEARING	
	31	511400 10400	SET DISTANCE DISC	
	38	016801 21300	CLAMPING DISC	
	39	949807 00000	SCREW	
	41	945224 00000	HEX-HEAD SCREW	
	42	945218 00000	HEX-HEAD SCREW	
	43	901804 00000	HEX-HEAD SCREW	
	45	948742 00000	STRAIGHT PIN	
	47	947736 00000	KEY	
	50	053201 21300	CONNECTION FLANGE	
	52	950308 00000	WASHER	
	53	945331 00000	SOCKET HEAD SCREW	
	56	544500 21300	COUPLING WITH FAN	
	57	949409 00000	WASHER	
	58	945270 00000	SHAFT END BOLD	
	61	040102 21300	FILTER HOUSING	
	62	025501 21300	GASKET	
	64	951009 00000	STUD	
	65	951003 00000	STUD	
	67	964407 00000	SILENCER TUBE	
	68	909507 00000	FILTER CARTRIDGE (2x) ²⁾	
	71	009000 27000	LEAF SPRING	
	72	948750 00000	BLIND RIVET	
	73	040204 21300	FILTER COVER	
	75	025518 21300	GASKET	
	76	025516 21100	GASKET	
	77	022802 21100	FILTER HOLDER	
	79	945321 00000	SOCKET HEAD SCREW	
	80	946971 00000	STUD	
	81	947504 00000	WASHER	
	82	947104 00000	HEX.NUT	
	83	952019 00000	LOCATING PEG	
	85	025514 21100	GASKET	
	86	025515 21100	GASKET	
	88	560203 21300	COOLER	
	91	909514 00000	FILTER CARTRIDGE (1x) ²⁾	
	93	903800 70000	STUD	
	94	947105 00000	HEX.NUT	
	95	949450 00000	WASHER	
	96	964446 00000	SILENCER TUBE	
	97	950304 00000	WASHER	
	98	945321 00000	SOCKET HEAD SCREW	
	103	068801 21300	DUST SEPARATOR COVER	
	104	025515 21300	GASKET	
	110	921500 50000	HANDLE	
	121	560204 21300	COOLER	

W INDEX	Pos.	Ident No.	Description	
	122	025506 21300	GASKET	
	123	066802 21300	PRESSURE CONNECTION BOX	
	125	025504 21300	GASKET	
	126	025514 21300	GASKET	
	131	948021 00000	SEALING RING	
	132	945374 00020	SOCKET HEAD SCREW	
	137	945322 00000	SOCKET HEAD SCREW	
	141	016604 21300	CONNECTING PIECE	
	146	025507 21300	GASKET	
	148	945364 00000	SOCKET HEAD SCREW	
	149	741310 30000	RUBBER BUFFER	
	161	918300 21300	COVERING HOOD	
	163	920800 21300	AIR GUIDE COVER RING	
	163	920801 21300	AIR GUIDE COVER RING (DVT3.140/0-68)	
	165	960700 21300	VENTILATOR HOOD	
	166	960701 21300	VENTILATOR HOOD	
	170	945321 00010	SOCKET HEAD SCREW	
	171	945371 00010	SOCKET HEAD SCREW	
	172	945372 00010	SOCKET HEAD SCREW	
	173	949806 00000	SCREW	
	174	951703 00000	SPRING DISC	
	176	741302 00000	RUBBER BUFFER	
	177	945634 00000	THREADED PIN	
	178	948802 00000	RING SCREW	
	182	014903 21300	FLANGE (B5-300)	
	184	951916 00000	RUBBER BUSHING	
	185	948772 00000	PIPE RIVET	
	186	947508 00000	WASHER	
	188	945335 00000	SOCKET HEAD SCREW	
	191	951022 00000	STUD	
	192	947506 00000	WASHER	
	193	947106 00000	HEX.NUT	
	198	902100 21900	COUPLING (MOT)	
	199	902210 00000	COUPLING DISC	
	241	012200 21300	OIL-PIPE	
	244	912300 00000	CONNECTING SCREW	
	245	009400 19000	HOLLOW HOLDING SCREW	
	247	948074 00000	SEALING RING	
	248	948021 00000	SEALING RING	
	250	949002 00000	GREASE NIPPLE	
	341	736000 99624	VACUUM REGULATION VALVE (-8,7 PSI)	
	345	728000 99622	PRESSURE REGULATION VALVE (+8,7 PSI)	
		743303 00000	SPECIAL GREASE (GREASE PRESS, 50g)	

¹⁾ Set of seals - 54900021300 - Pos.: 17, 20, 24, 62, 75, 76, 85, 86, 104, 122, 125, 126, 146
²⁾ necessary order quantity / maintenance

W INDICE	Pos.	No. Identification	Designation	FR	
DVT 3.140	■	549000 21300	JEU DE JOINTS ¹⁾		
	5	000100 21300	CORP DE POMPE		
	8	020002 21300	PISTON		
	11	901334 00007	PALETTE DE CHARBON (KIT)		
	13	000800 21300	COUVERCLE A GAUCHE		
	14	000700 21300	COUVERCLE A DROITE		
	17	025512 21300	JOINT		
	18	001101 21300	COUVERCLE DE ROULEMENTE		
	19	001006 21300	COUVERCLE DE ROULEMENTE		
	20	025513 21300	JOINT		
	24	911305 00000	JOINT		
	25	917159 00000	DISQUE DE COMPENSATION		
	26	906544 00000	BAGUE D'ETANCHEITE P.L'AXE		
	27	906621 00000	ROULEMENT A BILLES		
	28	906664 00000	ROULEMENT A BILLES		
	31	511400 10400	JEU DISQUE DE TOLERANCE		
	38	016801 21300	DISQUE DE SERRAGE		
	39	949807 00000	VIS		
	41	945224 00000	VIS HEXAGONALE		
	42	945218 00000	VIS HEXAGONALE		
	43	901804 00000	VIS HEXAGONALE		
	45	948742 00000	GOUPILLE CYLINDRIQUE		
	47	947736 00000	CLAVETTE		
	50	053201 21300	BRIDE DE RACCORDEMENT		
	52	950308 00000	RONDELLE		
	53	945331 00000	VIS HEXAGONALE INTERNE		
	56	544500 21300	ACCOUPLLEMENT AVEC VENTILATEUR		
	57	949409 00000	RONDELLE		
	58	945270 00000	VIS BOUT D'ARBRE		
	61	040102 21300	BOITE POUR FILTRE		
	62	025501 21300	JOINT		
	64	951009 00000	PRISONNIER		
	65	951003 00000	PRISONNIER		
	67	964407 00000	TUBE SILENCIEUX		
	68	909507 00000	CARTOUCHE FILTRANTE (2x) ²⁾		
	71	009000 27000	RESSORT-JAME		
	72	948750 00000	RIVET AVEUGLIE		
	73	040204 21300	COUVERCLE DE FILTRE		
	75	025518 21300	JOINT		
	76	025516 21100	JOINT		
	77	022802 21100	SUPPORT FILTRE		
	79	945321 00000	VIS HEXAGONALE INTERNE		
	80	946971 00000	PRISONNIER		
	81	947504 00000	RONDELLE		
	82	947104 00000	ECROU A 6PANS		
	83	952019 00000	DOUILLE DE ETRAGE		
	85	025514 21100	JOINT		
	86	025515 21100	JOINT		
	88	560203 21300	REFROIDISSEUR		
	91	909514 00000	CARTOUCHE FILTRANTE (1x) ²⁾		
	93	903800 70000	PRISONNIER		
	94	947105 00000	ECROU A 6 PANS		
	95	949450 00000	RONDELLE		
	96	964446 00000	TUBE SILENCIEUX		
	97	950304 00000	RONDELLE		
	98	945321 00000	VIS HEXAGONALE INTERNE		
	103	068801 21300	COUVERCLE		
	104	025515 21300	JOINT		
	110	921500 50000	POIGNEE		
	121	560204 21300	REFROIDISSEUR		

W INDICE	Pos.	No. Identification	Designation	FR	
	122	025506 21300	JOINT		
	123	066802 21300	BOITIER DE RACCORD DE REFOULEMENT		
	125	025504 21300	JOINT		
	126	025514 21300	JOINT		
	131	948021 00000	JOINT		
	132	945374 00020	VIS HEXAGONALE INTERNE		
	137	945322 00000	VIS HEXAGONALE INTERNE		
	141	016604 21300	PIECE RACCORD		
	146	025507 21300	JOINT		
	148	945364 00000	VIS HEXAGONALE INTERNE		
	149	741310 30000	AMORTISSEUR EN CAOUTCHOUC		
	161	918300 21300	CARTER		
	163	920800 21300	CAPOT DE CANALISATION DE L'AIR		
	163	920801 21300	CAPOT DE CANALISATION DE L'AIR (DVT3.140/0-68)		
	165	960700 21300	CARTER DE VENTILATEUR		
	166	960701 21300	CARTER DE VENTILATEUR		
	170	945321 00010	VIS HEXAGONALE INTERNE		
	171	945371 00010	VIS HEXAGONALE INTERNE		
	172	945372 00010	VIS HEXAGONALE INTERNE		
	173	949806 00000	VIS À TÊTE NOYÉE		
	174	951703 00000	DISQUE DE RESSORT		
	176	741302 00000	AMORTISSEUR EN CAOUTCHOUC		
	177	945634 00000	GOUPILLE FILETEE		
	178	948802 00000	PITON		
	182	014903 21300	BRIDE (B5-300)		
	184	951916 00000	PROTECTION EN CAOUTCHOUC		
	185	948772 00000	RIVET TUBE		
	186	947508 00000	RONDELLE		
	188	945335 00000	VIS HEXAGONALE INTERNE		
	191	951022 00000	PRISONNIER		
	192	947506 00000	RONDELLE		
	193	947106 00000	ECROU A 6 PANS		
	198	902100 21900	ACCOUPLLEMENT		
	199	902210 00000	DISQUE D'ACCOUPLLEMENT		
	241	012200 21300	TUYEAU DE GRAISSAGE		
	244	912300 00000	VIS DE RACCORD		
	245	009400 19000	VIS CREUSE DE FIXATION		
	247	948074 00000	JOINT		
	248	948021 00000	JOINT		
	250	949002 00000	GRAISSEUR		
	341	736000 99624	SOUPAPE REGLAGE VIDE (-0,6 BAR)		
	345	728000 99622	SOUPAPE REGLAGE PRESSION (+0,6 BAR)		
		743303 00000	GRAISSE SPÉCIFIQUE (POMPE À GRAISSE, 50g)		



¹⁾ Jeu de joints - 54900021300 - Pos.: 17, 20, 24, 62, 75, 76, 85, 86, 104, 122, 125, 126, 146

²⁾ quantité nécessaire / entretien

W INDICE	Pos.	No. Identificazione	Designazione	IT	
DVT 3.140	■	549000 21300	KIT GUARNIZIONI ¹⁾		
	5	000100 21300	CARCASSA		
	8	020002 21300	ROTORE		
	11	901334 00007	PALETTE DI CHARBONE (KIT)		
	13	000800 21300	COPERCHIO SINISTRA		
	14	000700 21300	COPERCHIO DESTRA		
	17	025512 21300	GUARNIZIONE		
	18	001101 21300	COPERCHIO CUSCINETTO		
	19	001006 21300	COPERCHIO CUSCINETTO		
	20	025513 21300	GUARNIZIONE		
	24	911305 00000	GUARNIZIONE		
	25	917159 00000	DISCO COMPENSATORE		
	26	906544 00000	GUARNIZIONE PER L'ALBERO		
	27	906621 00000	CUSCINETTO A SFERA		
	28	906664 00000	CUSCINETTO A SFERA		
	31	511400 10400	SERIE DISCO GIUOCO		
	38	016801 21300	DISCO DI FISSAGGIO		
	39	949807 00000	VITE		
	41	945224 00000	VITE ESAGONALE		
	42	945218 00000	VITE ESAGONALE		
	43	901804 00000	VITE ESAGONALE		
45	948742 00000	PERNO			
47	947736 00000	CHIAVETTA			
50	053201 21300	FLANGIA DI RACCORDE			
52	950308 00000	RONDELLA			
53	945331 00000	VITE ESAGONALE INTERNA			
56	544500 21300	GIUNTO CON VENTILATORE			
57	949409 00000	RONDELLA			
58	945270 00000	VITE DI CHIUSURA ALBERO			
61	040102 21300	CONTENITORE FILTRO			
62	025501 21300	GUARNIZIONE			
64	951009 00000	L'ASTA A VITE			
65	951003 00000	L'ASTA A VITE			
67	964407 00000	TUBO SILENZIATORE			
68	909507 00000	CARTUCCIA FILTRO (2x) ²⁾			
71	009000 27000	MOLLA			
72	948750 00000	RIVETTO CIECO			
73	040204 21300	COPERCHIO FILTRO			
75	025518 21300	GUARNIZIONE			
76	025516 21100	GUARNIZIONE			
77	022802 21100	SUPPORTO FILTRO			
79	945321 00000	VITE ESAGONALE INTERNA			
80	946971 00000	L'ASTA A VITE			
81	947504 00000	RONDELLA			
82	947104 00000	DADO ESAGONALE			
83	952019 00000	SPINE DI RISCONTRO			
85	025514 21100	GUARNIZIONE			
86	025515 21100	GUARNIZIONE			
88	560203 21300	RAFFREDDATORE			
91	909514 00000	CARTUCCIA FILTRO (1x) ²⁾			
93	903800 70000	L'ASTA A VITE			
94	947105 00000	DADO ESAGONALE			
95	949450 00000	RONDELLA			
96	964446 00000	TUBO SILENZIATORE			
97	950304 00000	RONDELLA			
98	945321 00000	VITE ESAGONALE INTERNA			
103	068801 21300	COPERCHIO			
104	025515 21300	GUARNIZIONI			
110	921500 50000	MANETTA			
121	560204 21300	RAFFREDDATORE			

W INDICE	Pos.	No. Identificazione	Designazione	IT	
	122	025506 21300	GUARNIZIONE		
	123	066802 21300	SCATOLA DI RACCORDO DI MANDATA		
	125	025504 21300	GUARNIZIONE		
	126	025514 21300	GUARNIZIONI		
	131	948021 00000	ANELLO GUARNIZIONE		
	132	945374 00020	VITE ESAGONALE INTERNA		
	137	945322 00000	VITE ESAGONALE INTERNA		
	141	016604 21300	PEZZI RACCORDI		
	146	025507 21300	GUARNIZIONE		
	148	945364 00000	VITE ESAGONALE INTERNA		
	149	741310 30000	AMMORTIZZATORE IN GOMMA		
	161	918300 21300	CARTER		
	163	920800 21300	CAPPOTTA DEL CONDOTTA ARIA		
	163	920801 21300	CAPPOTTA DEL CONDOTTA ARIA (DVT3.140/0-68)		
	165	960700 21300	CARTER VENTILATORE		
	166	960701 21300	CARTER VENTILATORE		
	170	945321 00010	VITE ESAGONALE INTERNA		
	171	945371 00010	VITE ESAGONALE INTERNA		
	172	945372 00010	VITE ESAGONALE INTERNA		
	173	949806 00000	VITE A TESTA SVASATA		
	174	951703 00000	DISCO A MOLLA		
	176	741302 00000	AMMORTIZZATORE IN GOMMA		
	177	945634 00000	SPINA FILETTATURA		
	178	948802 00000	GANCIO		
	182	014903 21300	FLANGIA (B5-300)		
	184	951916 00000	PROTEZIONE IN GOMMA		
	185	948772 00000	CHIODI TUBOLARE		
	186	947508 00000	RONDELLA		
	188	945335 00000	VITE ESAGONALE INTERNA		
	191	951022 00000	L'ASTA A VITE		
	192	947506 00000	RONDELLA		
	193	947106 00000	DADO ESAGONALE		
	198	902100 21900	GIUNTO		
	199	902210 00000	DISCO GIUNTO		
	241	012200 21300	CONDOTTO		
	244	912300 00000	ATTACO FILETTATO		
	245	009400 19000	VITE PASSAGGIO OLIO		
	247	948074 00000	ANELLO GUARNIZIONE		
	248	948021 00000	ANELLO GUARNIZIONE		
	250	949002 00000	RACCORDO DI LUBRIFICAZIONE		
	341	736000 99624	VALVOLA REGOLAZIONE VUOTO (-0,6 BAR)		
	345	728000 99622	VALVOLA REGOLAZIONE PRESSIONE (+0,6 BAR)		
		743303 00000	GRASSO SPECIALE (INGRASSATORE A PISTOLA, 50g)		

¹⁾ Serie di guarnizione - 54900021300 - Pos.: 17, 20, 24, 62, 75, 76, 85, 86, 104, 122, 125, 126, 146
²⁾ quantità di ordinazione necessari / manutenzione

DVT 3.140	Variante 	Pos.	Bestell Nr. / Ident No. / No. Identification / No. Identificazione / No. De pedido		Beschreibung / Description / Designation / Designazione / Desripcion
					
① 1.+2.Ansaugung 1.+2.suction 1.+2.aspiration 1.+2.aspirazione 1.+2.aspiración		96		964445-00000	SCHALLDÄMPFERROHR / SILENCER TUBE / TUBE SILENCIEUX / TUBO SILENZIATORE / TUBO DE SILENCIADOR
		141		016604-21300	ANSCHLUSSLEISTE / CONNECTING PIECE / PIECE RACCORD / PEZZI RACCORDI / PIEZA DE EMPALME
		144	016603 21300		ANSCHLUSSLEISTE / CONNECTING PIECE / PIECE RACCORD / PEZZI RACCORDI / PIEZA DE EMPALME
		342	736000 99613		VAKUUMREGULIERVENTIL (-0,3 BAR) / VACUUM REGULATION VALVE (-4,35 PSI) / SOUPAPE REGLAGE VIDE (-0,3 BAR) / VALVOLA REGOLAZIONE VUOTO (-0,3 BAR) / VÁLVULA REGULADORA DE VACÍO (-0,3 BAR)
② US Motoranschluß US motor US moteur US motore US motor		190	951018 00000		STIFTSCHRAUBE / STUD / PRISONNIER / L'ASTA A VITE / ESPÁRRAGO
		191		951022-00000	STIFTSCHRAUBE / STUD / PRISONNIER / L'ASTA A VITE / ESPÁRRAGO
		198		902100-21900	KUPPLUNGSHÄLFTE (MOT) / COUPLING (MOT) / ACCOUPLEMENT (MOT) / GIUNTO (MOT) / MITAD DE ACOPLAMIENTO (MOT)
		234	037900 10400		ZWISCHENFLANSCH / FLANGE / BRIDE / FLANGIA / BRIDA INTERMEDIA
		235	902100 21300		KUPPLUNGSHÄLFTE (MOT) / COUPLING (MOT) / ACCOUPLEMENT (MOT) / GIUNTO (MOT) / MITAD DE ACOPLAMIENTO (MOT)
③ /0-56 - erhöhter Volumenstrom - increased volume flow - d'augmentation de débit - aumento del volume di flusso - aumento del volumen de flujo		6	000102 21300	000100-21300	GEHÄUSE / PUMP BODY / CORP DE POMPE / CARCASSA / CARCASA
		13	000802 21300	000800-21300	SEITENDECKEL, LINKS / LID LEFT / COUVERCLE A GAUCHE / COPERCHIO SINISTRA / TAPA LATERAL IZQUIERDA
		14	000702 21300	000700-21300	SEITENDECKEL, RECHTS / LID RIGHT / COUVERCLE A DROITE / COPERCHIO DESTRA / TAPA LATERAL DERECHA
		96		964446-00000	SCHALLDÄMPFERROHR / SILENCER TUBE / TUBE SILENCIEUX / TUBO SILENZIATORE / TUBO SILENCIADOR

²⁾ variantenabhängige Bauteile / variant-dependent components / composants variante-dependantes / componenti variante-dispendenti / componentes variante-dependientes